



Digital Fast Poll Modem

MIU9.6FPD

USER'S GUIDE



Raymar Information Technology, Inc.

7325 Roseville Road
Sacramento, CA 95842
800-695-1951
Fax: 916-783-1952

The products and programs described in this User's Guide are licensed products of Raymar-Telenetics. This User's Guide contains proprietary information protected by copyright, and this User's Guide and all accompanying hardware and documentation are copyrighted.

Raymar-Telenetics does not warrant that the hardware will work properly in all environments and applications, and makes no warranty and representation, either implied or expressed, with respect to the quality, performance, merchantability, or fitness for a particular purpose.

Information in this User's Guide is subject to change without notice and does not represent a commitment on the part of Raymar-Telenetics. Raymar-Telenetics assumes no responsibility for any inaccuracies that may be contained in this User's Guide.

Raymar-Telenetics makes no commitment to update or keep current the information in this User's Guide, and reserves the right to make changes to this User's Guide and/or product without notice.

No part of this manual may be reproduced or transmitted in any form or by any means, electronic or mechanical, including photocopying, recording, or information storage and retrieval systems, for any purpose other than the purchaser's personal use, without the express written permission of Raymar-Telenetics.

© Copyright 2010 Raymar Information Technology, Inc.
7325 Roseville Road
Sacramento, California 95842
Tel: 800-695-1951 Direct: +1-916-783-1951
Fax: 916-783-1952
Web site: www.raymarinc.com

TABLE of CONTENTS

1. INTRODUCTION.....	Page 1
2. INSTALLATION.....	Page 6
3. APPENDIX A - TROUBLESHOOTING.....	Page 15
4. APPENDIX B - SPECIFICATIONS	Page 18
5. APPENDIX C - COMPLIANCES.....	Page 23

CHAPTER ONE – INTRODUCTION

Congratulations for purchasing the finest industrial-grade digital, fast-poll modem available.

The Raymar-Telenetics MIU9.6FPD is a family of low-cost, state-of-the-art, 4-wire private-line asynchronous digital fast-poll modems designed for point-to-point and multipoint data communications over solid metallic circuits (such as pilot wires). The MIU9.6FPD provides the consistently high performance and unsurpassed reliability demanded by today's industrial and commercial applications. It also offers a range of data rates from 2400 to 19,200 bps.

The MIU9.6FPD comes in low-voltage and standard-voltage models. In addition, the MIU9.6FPD is internally surge-protected on both power and analog lines, and operates within the temperature range of -40°C to +85°C.

The MIU9.6FPD consists of a baseboard and a communication module:

- ❖ The baseboard includes the power supply regulation and surge protection.
- ❖ The communication module consists of a Raymar-Telenetics Pony Express™ PE9.6FPD modem module.

This User's Guide is designed to let you get your MIU9.6FPD "up and running" as quickly as possible. It contains all the information you need to configure and install your MIU9.6FPD. It also contains troubleshooting information in the unlikely event you encounter a problem with your MIU9.6FPD.

MODELS

The Raymar-Telenetics MIU9.6FPD fast-poll modems are available in four models. Table 1-1 describes the features for these models.

Table 1-1. Raymar-Telenetics MIU9.6FPD

Model Number	Feature Description
MIU9.6FPD-LV	<ul style="list-style-type: none"> ❖ Single-channel standalone modem ❖ 9.0 to 36 VDC voltage input power supply
MIU9.6FPD/R-LV	<ul style="list-style-type: none"> ❖ Single-channel standalone repeater ❖ 9.0 to 36 VDC voltage input power supply
MIU9.6FPD	<ul style="list-style-type: none"> ❖ Single-channel standalone modem ❖ 48 to 120 V AC/DC voltage input power supply
MIU9.6FPD/R	<ul style="list-style-type: none"> ❖ Single-channel standalone repeater ❖ 48 to 120 V AC/DC voltage input power supply

Note: In this User's Guide, MIU9.6FPD will be used collectively to refer to all models. If information pertains to certain models only, the appropriate model numbers in Table 1-1 will be used.

FEATURES

The MIU9.6FPD is specifically designed for harsh environments found in utility substations and industrial facilities. Though functionally similar to commercial modems, the MIU9.6FPD provides the following unique features that make it particularly well suited for utility and industrial applications.

- ❖ Packaged in a rugged, compact, non-metallic (ABS) enclosure for industrial applications.
- ❖ Requires no human intervention, making it ideal for unmanned locations.
- ❖ Works within an extended temperature range of -40°C to +85°C.
- ❖ Designed with coupling transformers and opto-isolator for high-voltage isolation and common mode noise rejection in industrial and commercial environments.
- ❖ Provides surge protection superior to those of conventional commercial modems.
- ❖ Accepts power from a wide range of AC and DC power supplies.
- ❖ Standard industrial connectors for data, analog, and power interfaces allow reliable interconnection to other industrial components.
- ❖ 2400, 4800, 9600, 19200 bps asynchronous data rates (selectable).
- ❖ DIP switch configuration.
- ❖ RS-232 DTE (RTU) interface.

APPLICATIONS

The MIU9.6FPD is designed for point-to-point and multipoint data communications. Figure 1-1 shows the MIU9.6FPD in a typical multipoint-with-repeater configuration.

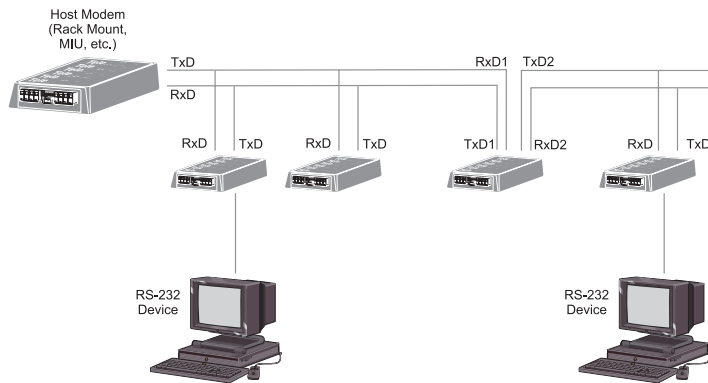

Figure 1-1. Sample Multipoint-with-Repeater Configuration

There are a number of factors that can affect the MIU9.6FPD's operation and performance. These include:

- ❖ Operating speed
- ❖ Wire gauge size of the transmission line
- ❖ Transmission line characteristics such as noise, interference, cross-talk, and distortions
- ❖ Network configuration (point-to-point or multipoint)
- ❖ Number of nodes on the network

Table 1-2 lists the operating distances for a single-channel MIU9.6FPD modem using 18 AWG, 24 AWG, and 26 AWG in a point-to-point configuration. Table 1-3 shows the same information for multipoint configurations.

Table 1-2. Operating Distances for Point-to-Point Configurations

Data Rate (bps)	Operating Distances		
	26 AWG	24 AWG	18 AWG
19,200	8,000 feet	10,000 feet	12,000 feet
9,600	16,000 feet	20,000 feet	25,000 feet
4,800	20,000 feet	25,000 feet	45,000 feet
2,400	34,000 feet	42,000 feet	60,000 feet

Table 1-3. Operating Distances for Multipoint Configurations

Multipoint @ 9,600 bps	Operating Distance Using 24 AWG
6 drops	17,000 feet
12 drops	15,000 feet
16 drops	12,000 feet

CHAPTER TWO – INSTALLATION

This chapter describes how to install the MIU9.6FPD.

Unpacking Your Hardware

Your package should include at least one MIU9.6FPD modem or repeater. If your package contents are damaged or missing, please contact your place of purchase immediately.

Additional Items You Need

To use your MIU9.6FPD modem, you need the following additional items:

- ❖ Four-wire transmission line
- ❖ A communications interface to the MIU9.6FPD terminal block
- ❖ An appropriate power supply:
 - Models MIU9.6FPD-LV and MIU9.6FPD/R-LV accept 9.0 to 36 VDC.
 - Models MIU9.6FPD and MIU9.6FPD/R accept 48 to 120 V AC/DC.

HARDWARE OVERVIEW

Figure 2-1 shows the front view of the modem. This view shows:

- ❖ Two sets of configuration switches. Use the top switches to configure the modem module. The bottom switches remain at their factory settings.
- ❖ A transmission interface on the left side. The repeater has a second transmission interface on the right side; leave the right interface unused if you will not be performing repeater applications.
- ❖ Red (send data) and green (receive data) LEDs.

Figure 2-2 shows the back view of the modem. This view shows:

- ❖ A power interface on the right side for connecting to a voltage source.
- ❖ A female, 9-pin RS-232 connector on the left side, for connecting a standard DTE (RTU).
- ❖ A red LED between the RS-232 connector and power interface.

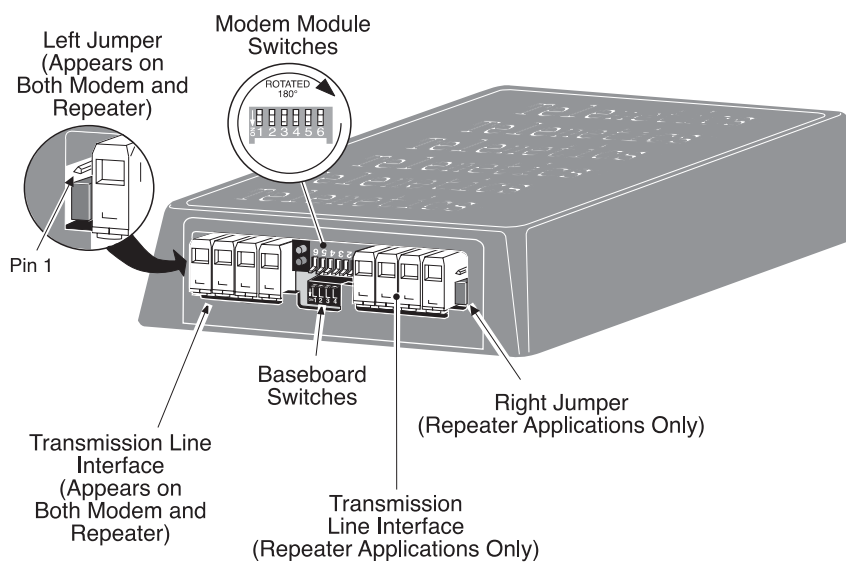

Figure 2-1. Front View

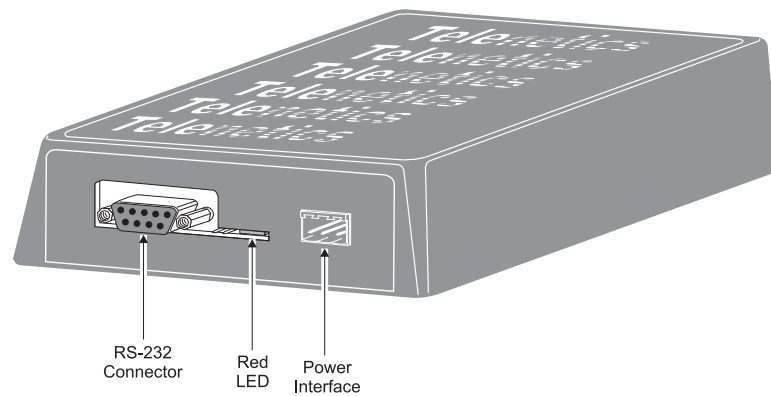

Figure 2-2. Back View

INSTALLATION SUMMARY

The MIU9.6FPD installation involves the following steps:

1. Finding a suitable location for the modem. See the section below.
2. Configuring the modem module.
3. Connecting to a transmission line..
4. Connecting to a voltage source.
5. *Optional:* Connecting a DTE device.

Note: The back panel of the baseboard has four DIP switches. Leave these switches in their factory-set positions.

FINDING A SUITABLE LOCATION

Its rugged enclosure and ability to work within a broad temperature range (-40°C to +85°C) make your modem ideal for use in locations unsuitable for other modems. The location you select should provide easy access to the back panel communications interface(s) and front panel power interface. It should also let you view the red and green LEDs on the front panel.

Note: Raymar-Telenetics offers a rack-mount version of this modem.

Configuring the Modem Module

You configure the modem module using the six DIP switches on the modem front panel and one jumper. Figure 2-1 shows the location of the switches and jumper.

Switch Settings

The modem has six front panel DIP switches. Table 2-1 describes the switch settings.

Note: For your convenience, the bottom of your modem has a label that summarizes the configuration DIP switch settings.

Table 2-1. Switch Settings

Switch Functions	Switch Settings					
	1	2	3	4	5	6
Switch 1: Anti Streaming* Enabled Disabled	ON OFF					
Switch 2: Transmit Analog (TxA) Signal Level** 0 dBm -10 dBm		ON OFF				
Switches 3-6: Data Rate*** 19,200 bps 9,600 bps 4,800 bps 2,400 bps			ON OFF OFF OFF	OFF ON OFF OFF	OFF OFF ON OFF	OFF OFF OFF ON
* Anti-streaming prevents slave modems from transmitting continuously and snarling the network. ** For maximum operating distance, select 0 dBm. *** For Switches 3 through 6, only one of these switches can be set to the ON position.						

Jumper Setting

The modem module has a jumper for selecting the impedance (see Figure 2-1). You can access the jumper from the front panel of the PE9.6FPD.

Table 2-2 describes the jumper settings. For your convenience, the bottom of your modem has a label that summarizes the jumper settings.

Table 2-2. Jumper Settings

To Select...	Strap the Jumper Between...
600 Ω Rx impedance.	Pins 1 and 2.
High impedance for multipoint configurations.	Pins 2 and 3. (<i>default setting</i>)
Note: For point-to-point configurations, both ends should be terminated with 600 Ω Rx impedance. For multipoint configurations, the host and the distant modem should be terminated to 600 Ω Rx impedance.	

CONNECTING to a TRANSMISSION LINE

The MIU9.6FPD has a transmission line interface on the front panel (see Figure 2-1):

- ❖ The single-channel standalone modem has one transmission line interface.
- ❖ The repeater has two transmission line interfaces. The left interface is for connection to a host modem and computer, while the right is for a repeater connection. If you will not be performing repeater applications, do not use the right interface.

Each transmission line interface is a 4-wire, analog connection, where one pair is used to transmit data (Tx+ and Tx-) and one pair is used to receive data (Rx+ and Rx-). Tables 2-3 and 2-4 show the pin numbers and corresponding signals for the single-channel modem and repeater.

Table 2-3. Single-channel Analog Interface

This Pin Number...	Corresponds to This Signal...
TB-A-pin 1	Tx+
TB-A-pin 2	Tx-
TB-A-pin 3	Rx-
TB-A-pin 4	Rx+

Table 2-4. Repeater Analog Interface

This Pin Number...	Corresponds to This Signal...
TB-B-pin 1	Tx+
TB-B-pin 2	Tx-
TB-B-pin 3	Rx-
TB-B-pin 4	Rx+

For communications to occur, the polarity of the transmit and receive lines from one MIU9.6FPD to another must connect as shown below:

Tx+	⇒	RX+
Tx-	⇒	Rx-
Rx+	⇒	Tx+
Rx-	⇒	Tx-

Important: Polarity of the transmission line must be followed. If connections are reversed, no data will be received.

CONNECTING to a VOLTAGE SOURCE

The back panel of the MIU9.6FPD provides the power interface (see Figure 2-2). For convenience, the MIU9.6FPD models can be powered from a wide range of power supplies. For example, the MIU9.6FPD-LV can be powered from a 12 VDC auxiliary supply on other equipment, while the MIU9.6FPD can be powered from a standard 120 VAC outlet.

The valid power ranges for the MIU9.6FPD vary by model. Table 2-5 lists the power ranges for the MIU9.6FPD models. Figure 2-3 shows the connection to the MIU9.6FPD's power interface.

Note: Before you connect to a voltage source:

- ❖ Be sure the voltage source is within the permitted range in Table 2-5. Otherwise, your MIU9.6FPD and any attached devices may be damaged.
- ❖ Customer-supplied cables must be suitable for the site environmental conditions.
- ❖ Screw terminals on the power interface accept 28 to 16 AWG. However, surge protection is guaranteed only if the ground wire is greater than 18 AWG and if there is a solidly earthed ground connection.
- ❖ Be sure the power source is not controlled by a wall switch, which can be inadvertently turned off, shutting off power to the MIU9.6FPD.

Table 2-5. Voltage Ranges

This Model...	Accepts This Voltage Range...
MIU9.6FPD-LV and MIU9.6FPD/R-LV	9.0 to 36 VDC
MIU9.6FPD and MIU9.6FPD/R	48 to 120 V AC/DC

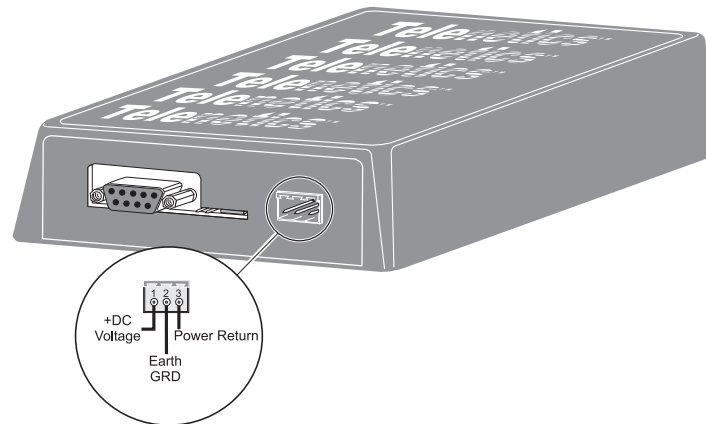

Figure 2-3. Voltage Connection to the Modem

CONNECTING an RS-232 DEVICE

The back panel of the MIU9.6FPD provides a female, 9-pin RS-232 connector (see Figure 2-2). This connector accepts a standard connection to a DTE (RTU), such as an IBM or compatible personal computer or VT100 terminal, that conforms to the pin assignments shown under “RS-232 (RTU) Interface”.

LEDs

The MIU9.6FPD front panel has two LEDs (see Figure 2-1):

- ❖ The top LED blinks green when data is being received.
- ❖ The bottom LED blinks red when data is being sent.

The MIU9.6FPD back panel has one red LED (see Figure 2-2). This LED:

- ❖ Blinks once per second when power is on, but no data is being received.
- ❖ Stays on continuously when data is being received.

APPENDIX A – TROUBLESHOOTING

In the unlikely event you encounter a problem using the MIU9.6FPD, refer to the troubleshooting information in this appendix.

PROBLEM SOLVING

Table A-1 offers troubleshooting solutions for modem problems.

Table A-1. Troubleshooting Suggestions

If...	Perform These Procedures...
The modem does not respond to the attached DTE and all LEDs are off.	Check the power supply input for your specific model.
The modem does not receive data and the green LED on the front panel does not blink.	The receive line pair may be disconnected from the modem or polarity may be reversed. Make sure the transmission line connection to the modem is accurate and secure.
The modem does not transmit data and the red LED on the front panel does not blink.	The attached terminal or DTE may not be sending data to the modem. Verify that data is being transmitted. If data is being transmitted, make sure the RS-232 cable is sound and securely connected to the modem and terminal or DTE.
All LEDs on the modem module are working, but the attached computer does not work or the modem receives data errors.	Verify all switch settings on the modem. Make sure the modem and computer are configured for the same operating speed. If necessary, perform the loopback test.
The baseboard jumper and switches have been changed from their factory settings.	See “Baseboard Module Configuration Settings.”

BASEBOARD MODULE CONFIGURATION SETTINGS

Figure A-1 shows the jumper and switch locations on the baseboard. Table A-1 shows the factory-set jumper and switch settings for the low-voltage baseboards (Models MIU9.6FPD-LV and MIU9.6FPD/R-LV). Table A-1 shows the factory-set jumper and switch settings for the standard-voltage baseboards (Models MIU9.6FPD and MIU9.6FPD/R).

Do not change these factory settings.

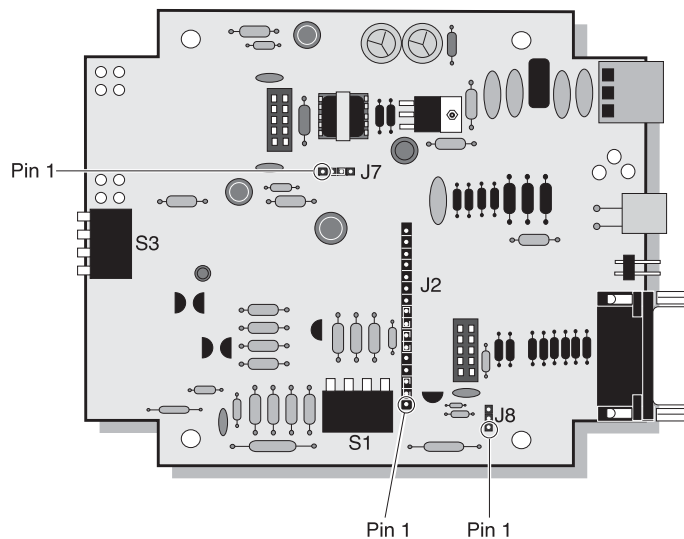

Figure A-1. Baseboard Module Switch and Jumper Locations

Table A-1. Factory Settings for Low-Voltage Baseboard Module

This Switch/Jumper	Has the Following Factory Settings...
J2	Pins 2 and 3 strapped. Pins 6 and 7 strapped. Pins 8 and 9 strapped.
J7	Pins 2 and 3 strapped.
J8	Pins 1 and 2 strapped.
S1	Switches 2 and 3 ON.
S3	Switches 1, 2, and 4 ON. Switch 3 OFF.

Table A-2. Factory Settings for Standard-Voltage Baseboard Module

This Switch/Jumper	Has the Following Factory Settings...
J2	Pins 2 and 3 strapped. Pins 6 and 7 strapped. Pins 8 and 9 strapped.
J7	Pins 2 and 3 strapped.
J8	Pins 1 and 3 strapped.
S1	Switches 2 and 3 ON.
S3	Switches 1, 2, and 4 ON. Switch 3 OFF.

LOOPBACK TEST

Loopback Test for Single Channel

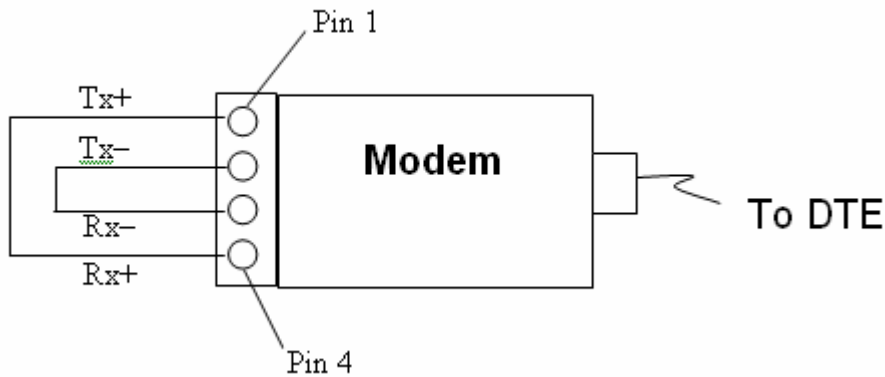

Loopback Test for Repeater

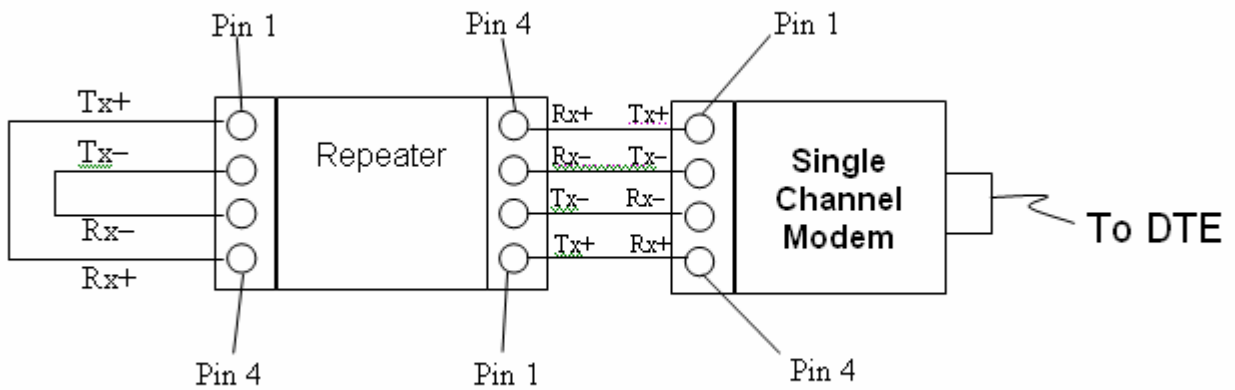

APPENDIX B – SPECIFICATIONS

GENERAL SPECIFICATIONS

Dimensions

Models: MIU9.6FPD-LV, MIU9.6FPD/R-LV, MIU9.6FPD, MIU9.6FPD/R

Width: 4.0 inches
Length: 5.5 inches
Height: 1.4 inches
Weight: 9.0 ounces

Model: PE9.6FPD

Width: 2.2 inches
Length: 3.5 inches
Height: 0.55 inches
Weight: 1.5 ounces

Voltage Supply

Models: MIU9.6FPD-LV and MIU9.6FPD/R-L

9.0 to 36 VDC

Models: MIU9.6FPD and MIU9.6FPD/R

48 to 120 V AC/DC

Surge Protection

Power Supply: 8k Vrms

ENVIRONMENTAL SPECIFICATIONS

Power Supply

Models: MIU9.6FPD-LV and MIU9.6FPD/R-LV

Input Supply: 9.0 to 36.0 Volts, DC

Power Consumption:

MIU9.6FPD-LV 1.0 Watt maximum

MIU9.6FPD/R-LV 1.2 Watts maximum

Model: MIU9.6FPD

Input Supply: 48 to 120 V AC/DC

Power Consumption: 1.0 Watt maximum

Temperature and Humidity

Operating Temperature: -40°C to +85°C

Operating Humidity: 0 to 95% non-condensing

Storage Temperature: -55°C to +125°C

MODEM SPECIFICATIONS

Modulation: Pulse Position Modulation (PPM)

Data Rate: 2400 to 19,200 bps asynchronous

Error Correction: None

Data Compression: None

Serial Formats: Asynchronous

Flow Control: None

INTERFACE CONNECTOR PIN ASSIGNMENTS

Model MIU9.6FPD-LV and Model PE9.6FPD Analog Interface

Pin Number	Corresponding Signal
TB-A-pin 1	Tx+
TB-A-pin 2	Tx-
TB-A-pin 3	Rx-
TB-A-pin 4	Rx+

MIU9.6FPD/R-LV and MIU9.6FPD/R Analog Interface

Pin Number	Corresponding Signal
TB-B-pin 1	Tx+
TB-B-pin 2	Tx-
TB-B-pin 3	Rx-
TB-B-pin 4	Rx+

RS-232 (RTU) Interface

DB9 (9-Pin) Connector

Pin Number	Input/Output	Signal Name
1	Out	CD
2	Out	RXD
3	In	TXD
4	In	DTR
5	—	SG
6	Out	DSR
7	In	RTS
8	Out	CTS
9	—	Not Used

DB25 (25-Pin) Connector

Pin Number	Input/Output	Signal Name
1	—	FG
2	In	TXD
3	Out	RXD
4	In	RTS
5	Out	CTS
6	Out	DSR
7	—	SG
8	Out	CD
20	In	DTR

PE Module

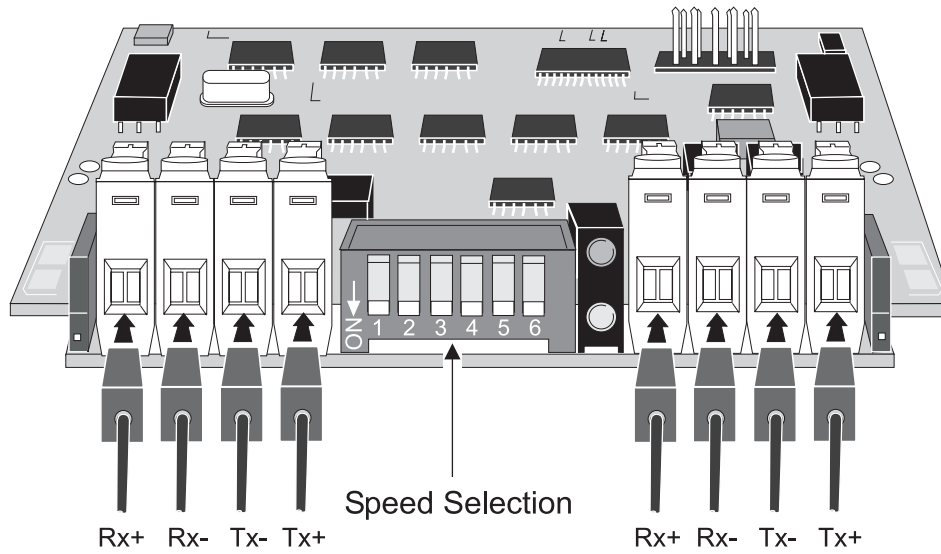

APPENDIX C – COMPLIANCES

This device complies with Part 15 of the FCC Rules. Operation is subject to the following two conditions: (1) this device may not cause harmful interference, and (2) this device must accept any interference received, including interference that may cause undesired operation.

This equipment has been tested and found to comply with the limits for a Class A digital device, pursuant to Part 15 of the FCC Rules. These limits are designed to provide reasonable protection against harmful interference in a residential installation. This equipment generates, uses, and can radiate radio frequency energy and, if not installed and used in accordance with the instructions, may cause harmful interference to radio communications. However, there is no guarantee that interference will not occur in a particular installation. If this equipment does cause harmful interference to radio or television reception, which can be determined by turning the equipment off and on, the user is encouraged to try to correct the interference by one or more of the following measures:

- ❖ Reorient or relocate the receiving antenna.
- ❖ Increase the separation between the equipment and the receiver.
- ❖ Connect the equipment to an outlet on a circuit other than the one to which the receiver is connected.
- ❖ Consult the dealer or an experienced radio/TV technician for help.

If none of these actions resolves the problem, consult your distributor or an experienced radio/television technician for additional suggestions.

Additionally, Section 15.838, paragraph d), of the FCC Rules and Regulations states: “Where special accessories, such as shielded cables, are required in order to meet FCC regulations, shielded cables must be used with this equipment. Operation with non-approved equipment or unshielded cables is likely to result in interference to radio and TV reception. The user is cautioned that changes and modifications to this equipment without the approval of the manufacturer could void the user’s authority to operate this equipment.

Raymar Information Technology, Inc. Limited Warranty

One Year Limited Hardware Warranty

Raymar Information Technology, Inc., dba Raymar-Telenetics, warrants their products against defects in hardware, material and workmanship under normal use for one (1) year from the date of purchase. Raymar will, at no charge, either repair the product (with new or reconditioned parts), or replace it (with a new or reconditioned product). Repaired replacement products are warranted for either 90 days or the remainder of the original warranty period, whichever is longer. This warranty extends to the original end-user only.

What This Warranty Does Not Cover

This warranty does not cover: (a) software; (b) installation or service of the product; (c) conditions resulting from consumer damage such as improper maintenance or misuse, abuse, accident or alteration; (d) all plastic surfaces (including display screens) and all other exposed parts that are scratched or damaged due to normal use; (e) operation of our products with equipment not supplied by Raymar (f) products which have had the serial number removed or made illegible; or (g) products rented to others. This warranty applies only to hardware products manufactured by or for Raymar Information Technology, Inc. and identified by the Raymar-Telenetics trademark, trade name or product identification logo affixed to them. Refer to the Service and Support section of the User's Guide for service after the warranty expires. No warranty is made as to coverage availability or grade of service provided by the carrier.

General Provisions

This warranty sets forth Raymar's entire hardware responsibilities regarding this product. Repair, replacement or refund of the purchase price is at Raymar's discretion. THIS WARRANTY IS GIVEN IN LIEU OF ALL OTHER EXPRESS WARRANTIES, IMPLIED WARRANTIES, INCLUDING WITHOUT LIMITATION IMPLIED WARRANTIES OF MERCHANTABILITY AND FITNESS FOR A PARTICULAR PURPOSE, AND ARE LIMITED TO THE DURATION OF THIS LIMITED WARRANTY. IN NO EVENT SHALL RAYMAR BE LIABLE FOR DAMAGES IN EXCESS OF THE PURCHASE PRICE OF THE PRODUCT, FOR ANY LOSS OF USE, LOSS OF TIME, INCONVENIENCE, COMMERCIAL LOSS, LOST PROFITS OR SAVINGS, OR OTHER INCIDENTAL, SPECIAL OR CONSEQUENTIAL DAMAGES ARISING OUT OF THE USE OR INABILITY TO USE THIS RAYMAR PRODUCT, TO THE FULL EXTENT SUCH MAY BE DISCLAIMED BY LAW. WITHOUT LIMITING THE FOREGOING, RAYMAR SHALL HAVE NO LIABILITY FOR ANY DATA STORED IN OR USED WITH THE PRODUCT, INCLUDING THE RECOVERY COSTS OF SUCH DATA OR PROGRAMS.

State Law Rights

SOME STATES DO NOT ALLOW THE EXCLUSION OR LIMITATION OF INCIDENTAL OR CONSEQUENTIAL DAMAGES OR LIMITATIONS ON HOW LONG AN IMPLIED WARRANTY LASTS. THE ABOVE LIMITATIONS OR EXCLUSIONS MAY NOT APPLY TO YOU. This warranty gives you specific legal rights, and you may also have other rights which vary from State to State.

Provincial Law Rights

SOME PROVINCIAL LAWS DO NOT ALLOW THE EXCLUSION OR LIMITATION OF IMPLIED WARRANTIES, THE EXCLUSION OR LIMITATION OF WARRANTY COVERAGE IN CERTAIN SITUATIONS. SOME OF THE ABOVE LIMITATIONS OR EXCLUSIONS CONTAINED IN THIS LIMITED WARRANTY MAY NOT APPLY TO YOU. This warranty gives you specific rights, and you may have other rights which vary from province to province.

How To Use Raymar's Limited Warranty Service

To take advantage of this warranty, you must do the following:

- If you are having trouble with your product, contact Raymar service using the appropriate number from the Service and Support section of the User's Guide. If it is determined that your product requires service, you will be issued a Return Materials Authorization (RMA) form.
- Pack the defective product securely for shipping. Include only the units pre-approved by service on your RMA form.
- This warranty is void if the product is damaged in transit, you must insure your shipment.
- Ship the defective product, proof of date of purchase, and the RMA form to the address specified.
- Display your RMA number prominently on the outside of the shipping box. Customer is responsible for freight in, door to door. Raymar is responsible for return shipping costs.
- To ensure prompt service, please write on the RMA form a brief description of the problem you are experiencing with the product.

Raymar Information Technology, Inc.
7325 Roseville Road
Sacramento, CA 95842
Service Hotline (800) 747-1522

<http://support.telenetics.com> or e-mail to techsupport@raymarinc.com

Raymar Information Technology, Inc. Return Merchandise Authorization (RMA) Procedure

Before returning any Raymar-Telenetics product, an RMA number must be obtained.

The most convenient way to obtain an RMA number for a product purchased from Raymar-Telenetics is to call **1-800-747-1522 (+1-916-783-1951)**. When doing so, please have the following information ready:

- Company name
- Full billing address, as well as the address for the location where the product should be returned once repaired or replaced
- Telephone & Fax numbers
- Email address
- Product model number and serial number

For each item being returned, please include the product model number, the serial number, a description of the problem being encountered, and the cause of the problem (if known).

Please note that prior to authorizing a return, a product support specialist may call to verify that the product is properly installed or may ask you to perform tests to insure that the product has actually failed.

The product must be properly packed and returned to:

**Raymar-Telenetics
7325 Roseville Road
Sacramento, CA 95842**

The RMA number must be legibly displayed on the shipping carton. Raymar-Telenetics will not be responsible for any product returned without an RMA number.

If the product is out of warranty, estimates for repair rates and any applicable shipping costs will be communicated by a customer service representative. Currently, Raymar-Telenetics accepts purchase orders or credit cards as payment methods.

Repairs currently require 5 – 10 business days and are returned via UPS Ground.